



**TVULTRA65-G3**  
**TVULTRA75-G3**  
**TVULTRA86-G3**

## **User's Manual for LCD Electronic Whiteboard**

---

**Note:** Please read this Manual carefully before using the product!

Do not attempt to disassemble the product. If the product does not work, please contact us or our dealer in your area.

# Foreword

Thanks for purchasing our LCD electronic whiteboard.

Please carefully read all accompanying documents before installing and using this product, as failure to operate according to the manual, or misoperation attributable to wrong understanding or other reasons, may result in electric shock, fire or other hazards. Pictures provided in this manual are for reference only. In case any picture deviates from the actual product, the latter shall prevail. To provide better services, we reserve the right to improve and modify this manual without further notice. Please keep this manual properly for future reference.

# Contents

<b>Safety Warnings</b> .....	1
<b>Precautions</b> .....	1
<b>Product Features</b> .....	2
<b>Accessories</b> .....	2
<b>Wall Mount</b> .....	3
<b>Port Connection</b> .....	3
<b>Instruction of Panel Buttons</b> .....	7
<b>Remote Control</b> .....	8
<b>Basic Operations</b> .....	9
Startup/Shutdown.....	9
Sidebar Setting.....	9
Signal Source Switching.....	10
Source Settings.....	10
Source Preview.....	11
Sound Mode.....	11
Network and Connection.....	11
Wallpaper.....	13
Language and Input Method.....	13
Date and Time.....	14
Security Settings.....	14
Power Settings.....	15
About.....	15
Other.....	16
Utilities.....	16
Multitask Manager.....	17
Turnoff.....	17
FileManager.....	18
Homepage.....	18
Writing Software.....	19
<b>Technical Parameters</b> .....	20
<b>Troubleshooting</b> .....	21
<b>Important Statement on Network Service</b> .....	21
<b>Toxic/Hazardous Substances/Elements in the Product</b> .....	22

## Safety Warnings

1. Use only the power supply and voltage indicated on the label.
2. A three-prong power cord is included. Confirm that the ground terminal of the wall outlet is well grounded before installation. Route the power cord away from passageways to avoid treading; also keep away from areas where the power cord may get pressed.
3. Do not overload the power outlet, and use a certified power outlet.
4. In case of thunderstorms, please pull out the power plug and the network cable and disconnect the product from the antenna to avoid damage.
5. If it is to be left unused for a long period of time, please power it off and pull out the power plug.
6. In case of any abnormal sound or smell, please power it off immediately and pull out the power plug. If necessary, stop using it and contact the maintenance personnel as soon as possible.
7. Keep away from flammable and explosive materials (e.g., candle, electric stove, bulb).
8. Be careful to prevent any liquid or metal objects from entering into the product; if so, stop using it immediately and contact the maintenance personnel.
9. When it is moved from a low-temperature environment to a warm area, condensate may form inside it. In such case, the product should be placed still for at least 24h prior to restart to air-dry the condensate.
10. Handle it with at least two persons; avoid impact and pay special attention to the display screen during the transfer.
11. To avoid injury, please install the base according to the instructions, and then place the product on an even and steady ground; or, if the base is not installed, the product should be firmly fixed to a wall according to the wall-mount bracket installation instructions.
12. Do not place the product in any environment:
  - To direct sunlight, moisture, high/low temperature, or dust.
  - To poor ventilation or an enclosed environment.
  - To where any flammable or explosive material is present.
  - To where any combustible or corrosive gas is present.
13. In order to avoid the risk of explosion, do not expose the batteries to sunlight, fire or high temperature.

## Precautions

- ◆ Do not attempt to disassemble/assemble this product as you may get exposed to dangerous voltage or other hazards. If necessary, please contact the maintenance personnel.
- ◆ If the product is dirty, first disconnect the power plug, then dampen the cloth with water and wipe with the slightly wet cloth. Do not apply force while wiping the display screen as it may scratch the screen. Do not wipe with such solvents as alcohol, gasoline, acid, alkali, detergent, volatile oil and diluents since these solvents may damage the product.
- ◆ Condensate may appear inside the screen in high humidity, and this is a normal phenomenon as generally temperature difference between the external and internal glass surfaces may lead to water droplets on the internal glass surface. Such water droplets will disappear automatically after 24h of normal use. Please rest assured to use the product.

## Precautions

- ◆ Do not insert any sharp or metal object into the vent or touch the signal connector with any sharp or metal object; otherwise short circuit or electric shock can be caused.
- ◆ Do not exert pressure on the LCD screen as it is made of glass.
- ◆ Do not place the product on an unsteady trolley, shelf or table; otherwise it may turn over. Move the product carefully when it is on a trolley. Emergency stop, excessive force or uneven ground can result in tipping over of the trolley and the product.
- ◆ Openings on the product are designed for heat dissipation to ensure good performance. Vent holes should not be covered with objects such as newspaper, tablecloth and curtain as they may impede ventilation.
- ◆ Do not allow a still picture or an active picture containing stationary text or icon to remain on the screen for too long because this will leave a “ghost image” on the screen, and it will not disappear long after shutdown.

## Product Features

This product uses HD LED-backlit panel, IR and multi-touch technologies. Equipped with a writing software, it is convenient, highly interactive, safe and environmentally friendly.

### ● High interconnectivity (optional)

This product can connect to other devices. It allows wireless connection with PCs, PADs and mobile phones, realizing wireless transmission of documents, wireless push of videos and wireless screen cast.

### ● Extraordinary Display

This product uses a high-quality HD LCD panel featuring original display color, vivid pictures, uniform display, no flickering, and quick response. You can enjoy HD pictures from different angles.

### ● Accurate Touch Control

This product incorporates the advanced touch technology featuring quick response, high positioning accuracy, strong environmental adaptability, accurate operation, etc. No stylus is needed; you can operate with your hand by clicking, dragging and other actions.

### ● Highly Interactive

This product is preinstalled with a professional writing software. It provides multiple types of pens, drawing tools and other functions, and you can write and move the contents as you like.

# Accessories

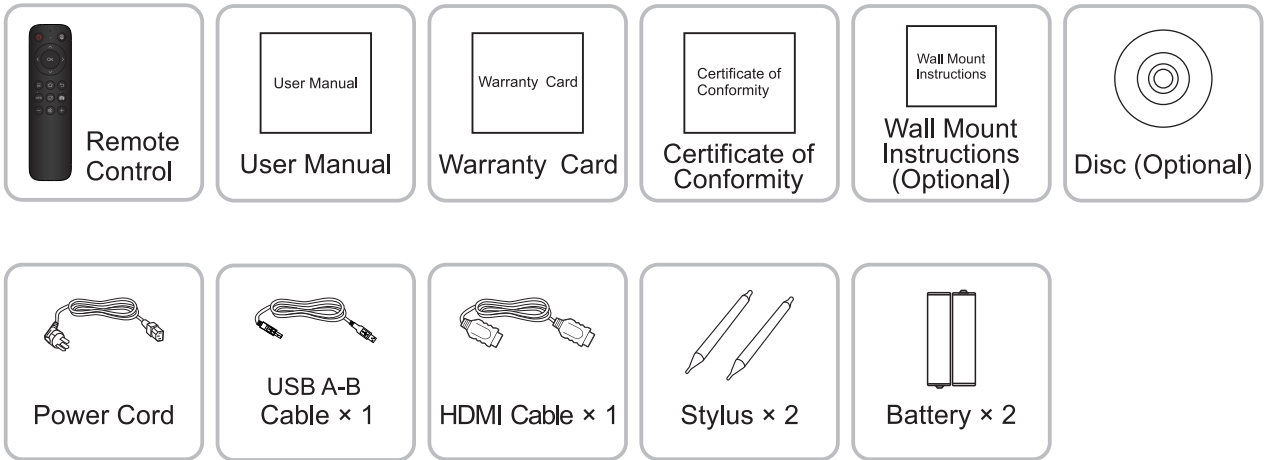

# Wall Mount

## 1. Precautions for Installation

- For installation of the wall-mount bracket, at least two professional workers are required; you should not attempt to install it, otherwise injury may result.
- During installation, assistance from professional workers is needed to designate the installation also, measures should be taken to make sure it can bear certain amount of external force. Make sure the bracket is installed onto a firm wall rather than plaster board or other surface which can not provide strong support.
- This product should be installed on a vertical plane, not on an oblique plane; also, it should not be installed with the front facing upwards; otherwise falloff of the product or personal injury may be caused.
- To avoid damage of the product or injury, keep the bracket out of the reach of children.
- Tighten the screws during installation to avoid product damage and injury.
- The installation is shown in the figure below; ventilation space should be kept around the product.

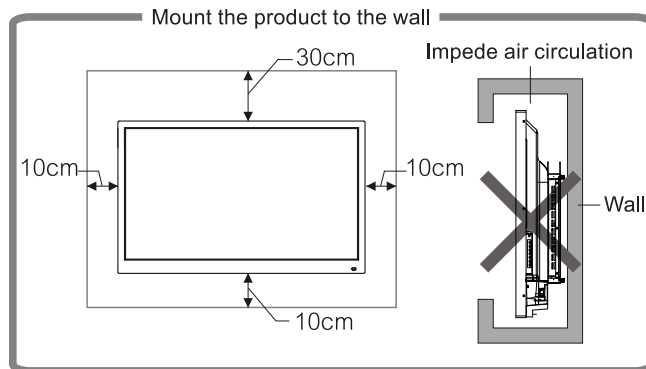

2. For specific installation steps, see the wall mount instructions.

# Port Connection

Note: The port connection instructions are provided below. The listed port types are for reference only, and do not cover all ports on this product.

## ■ Power port



## ■ Signal input ports

### ● USB port

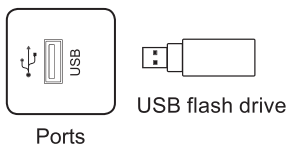

- ◆Note: 1. The native interface is USB2.0/3.0. The output current of USB2.0 port is 500mA, and that of USB3.0 port is 900mA. In order to ensure normal operation, please do not simultaneously use all USB ports to charge external devices.
- 2. Media USB port is used to connect external devices to the Android system of the product, which enables data reading via the file manager of this product.
- 3. This product is connected with wireless keyboard and mouse. In case of stuck operation or slow response, change the wireless receiver to another USB port, or use the USB extension cable to connect the wireless receiver, thus to enlarge the reception range.
- 4. Some nonstandard USB devices may be unrecognizable, please use standard USB devices.
- 5. For upgrading software with a flash drive, please use a USB2.0 flash drive.

### ● PUBLIC-USB port

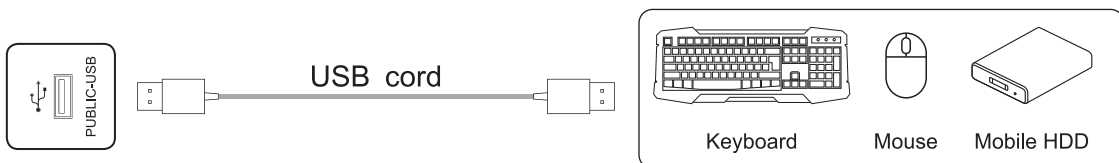

- ◆Note: 1. PUBLIC-USB port: this port is USB3.0 port, can support storage device read and write such as U Disk, hard disk, and also support USB keyboard & mouse connect and supply 5V 900mA power supply, This port can automatically switch through android and OPS system.
- 2. If connect mobile storage devices which need power supply, we suggest no more than 2 device connect at the same time.

# Port Connection

## ● TOUCH USB port

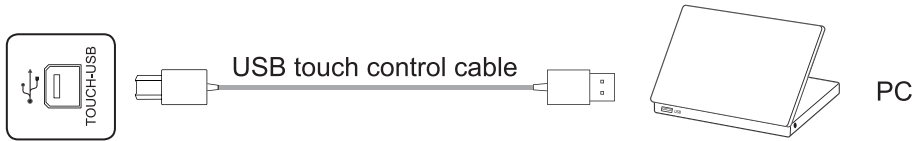

◆Note: When the TOUCH USB port is connected to the same device with the signal source, the external device can be operated by the TOUCH function.

## ● TYPE-C port

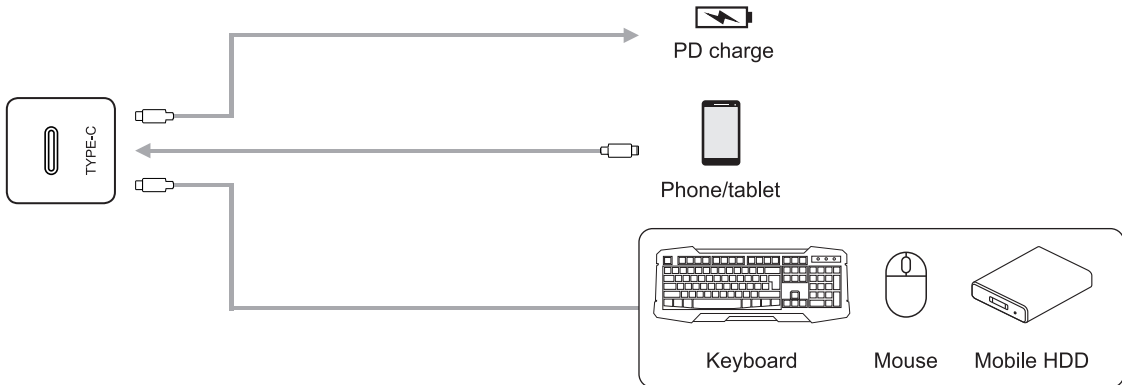

◆Note: 1. This interface is Type-C port, which can support PD power supply (Max up to 20V, 3A), DP signal display (connect to Type-C display devices, such as mobile phone, tablet and so on) and high speed USB data transmission.  
2. To ensure stable and reliable use, please match with certified standard wire.

## ● HDMI-IN port

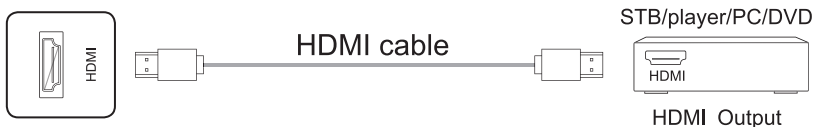

◆Note: The maximum resolution supported by HDMI port is 4K@60HZ, please see the section of technical parameters for the detailed signal formats. When 4K@60HZ signals are played, the EDID version in the OSD menu should be switched to EDID2.0.

## ● VGA audio/video port

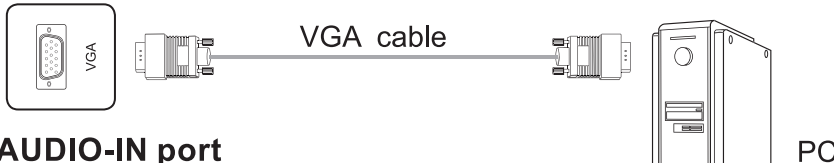

## ● AUDIO-IN port

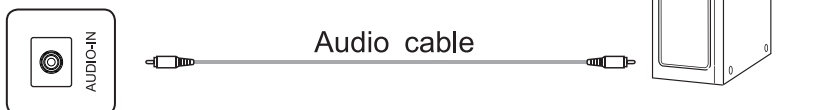

◆Note: For signal formats supported by the VGA port, see the Technical Parameters.



# Port Connection

## ● DP port

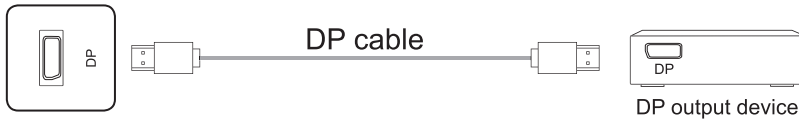

◆Note: the maximum resolution supported by DP port is 4K@60HZ. The signal quality depends on length and quality of the DP cable, so please use the recommended cables or those of famous brands on market.

## ■Signal output ports

### ●HDMI-OUT port

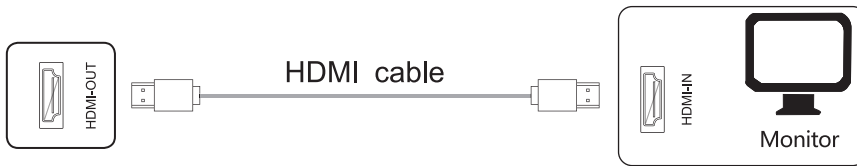

◆Note: the HDMI-OUT port can output Audio&Video signals to the HDMI-IN port of the second product, thesecond product can replay the Audio&Video signals to the third product, so on and so forth. The maximum relaying amount depends on quality and length of the HDMI cable, so it suggests using the cables provided by us.

## ■Audio ports

### ●Optical fiber port

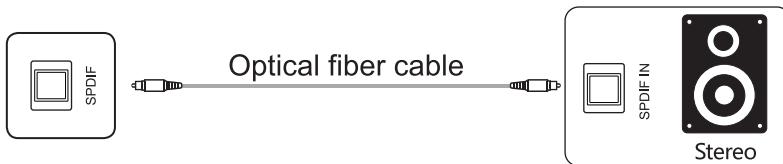

◆Note: this port can output audio signals of this product to speakers with a SPDIF-IN port.

### ●MIC port



◆Note: MIC port can be connected to microphone.

### ●AUDIO-OUT port



◆Note: Audio-OUT port can be connected with a headset or an external speaker.

# Port Connection

## Internet port

### LAN port



◆Note: 1. This interface is the network of control board, which can support the connection of wired network under Android, and can support 10M/100M/1000M adaptive. When connect each of the LAN port, and setting to connect the internet, the OPS can connect the internet too, only setting IP acquisition automatically.

## Control port

### RS232 port



◆Note: RS232-IN port is connected to the PC; the product is operated via the PC.

**Note: Please take the actual model interface as the criterion. Different models of equipment contain different types of interface.**

# Instruction of Panel Buttons

75/86 Inches

65 Inches

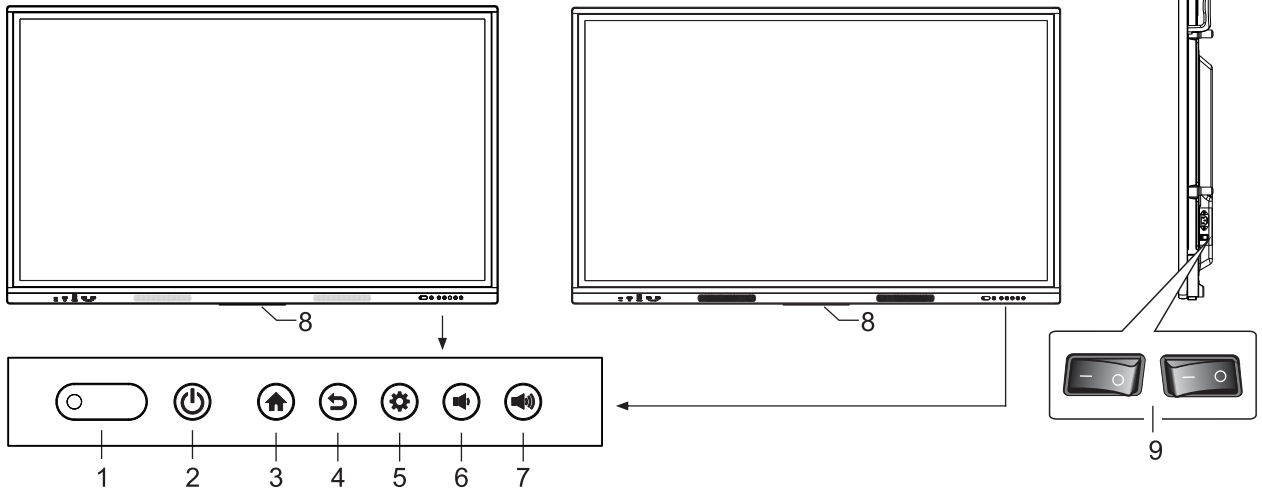

1. Indicator light, remote control receiver and light sensing receiver; 2. ⏻ : Power; 3. 🏠 : Homepage; 4. ⏪ : Return and touch unlock; 5. ⚙️ : Setting; 6. 🔊 : Vol-; 7. 🔊 : Vol+; 8. Position of WiFi antenna plastic fixing bracket; 9. Switch.

**Note: Different models appearance, please refer to the real object.**

# Remote Control

## Precautions for Use of Remote Control :

- Aim the remote control at the remote receiver when using the remote control. Any object placed between the remote control and the remote receiver may disturb the operation.
- Protect the remote control from vibration. Do not expose the remote control to direct sunlight as heat may deform it.
- When the remote receiver is subject to direct sunlight or strong light, the remote control may malfunction. In such case, please change the angle of lighting or the product, or operate the remote control close to the remote receiver.
- Replace the batteries in case of low battery as it will reduce the range of the remote control. If the remote control is to be left unused for a long period of time or the batteries are depleted, please remove the batteries as battery leakage may damage the remote control.
- Do not use batteries of different types or mix a new battery with a used one. Always replace batteries in pair.
- Do not throw batteries into a fire or recharge or disassemble batteries. Do not recharge, short-circuit, disassemble/assemble, heat or burn any used batteries. Please dispose of waste batteries according to applicable environmental regulations. Do not expose batteries to any hot environment, like direct sunlight, over the fire.

## Keys on the Remote Control

### Type A Remote Control

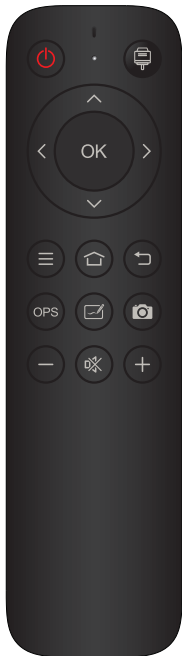

KEY	Function
POWER (⏻)	Switch between power-on and standby states
SOURCE (📶)	Open / close the signal source list
NAVIGATION KEYS (⏪ ⏩ ⏴ ⏵)	Select or adjust menu options
OK (OK)	Confirm the operation
MEUN (☰)	Show/hide the main menu
HOME (🏠)	Display the Android home page
BACK (⏪)	Return to the previous interface
OPS	Switch to OPS source
WRITING PAGE (✉)	Switch to the writing page
SNAPSHOT (📷)	Take a screenshot
VOL- (—)	Decrease the volume
MUTE (🔇)	Enable/disable sound
VOL+ (+)	Increase the volume

- 1.The picture is for reference only, subject to the actual remote control.
- 2.Functions of keys on the remote control may vary, subject to actual functions.

# Basic Operations

## Startup/Shutdown

### ◆ Startup/shutdown

Use 100-240V AC as the power supply.

⊖ on the panel and the remote control can be used to switch between power-on and standby states. ⊖ on the rear panel has two ends. Press the O end to power off the product; press the I end to power it on.

### ◆ Auto standby

In the Android main interface, whether there is signal input or not, the product will not enter the standby mode.

In the non-Android main interface, if there is no signal input within 15min, the product will automatically enter the standby mode.

### ◆ Save before shutdown

Before shutdown, the product will save the picture and sound settings. Upon restart, these settings will be used.

### ◆ OPS ON/OFF

If the product is installed with the OPS module and it is in OPS signal source, the OPS module will start automatically. If not, start it manually.









Before turning off the product, first use the touch function or mouse to turn off the OPS module from the Start menu. The Standby key on the panel or remote control can be used to turn off the product only after the OPS module completely shuts down. It is not allowed to press the Standby key or directly disconnect the power supply without turning off the OPS module as it will damage the OPS module.

When the OPS module enters the OFF state and no operation is performed on the PC for a long period of time, this product will enter standby. To use the module, just restart the product.

**Note: The OPS module is optional.**

## Sidebar Setting

Press the sidebar shortcut key arrow, or slide the edge of the screen inwards (when turn off the touch signal switch) to tune out the sidebar menu that are Return, Homepage, Source Settings, FileManager, Utilities, System Settings, Comment, MultitaskManager, Turnoff.

	Return	Return
	Homepage	Switch to Android homepage
	Source Settings	Source Settings, Source Preview
	FileManager	Whiteboard, Documents, Images, Videos, Audio, Archives, Apk
	Utilities	Screen Lock, Eye Protection, Calculator, Vote, Screencapture, Screen Recorder, Stopwatch, Spotlight, Touch Sound, Countdown
	System Settings	Network and Connection, Wallpaper, Language and Input Method, Date and Time, Security Settings, Power Settings, About, Other
	Comment	Open comment.
	MultitaskManager	View and manage backgroundrunning processes.
	Turnoff	Turn Off OPS, Turnoff

# Basic Operations

## Signal Source Switching

You can use the remote control or touch function to switch the source by the following methods:

Method one: press the “Signal Source” key on the remote controller to call “Signal Source Menu”, press the cursor key on the remote control to select a signal source, press the “OK” key, and then the product will switch to the input signal source that you selected.

Method two: selected the sidebar menu, click the “” icon, select the “Source Settings”, and then the product will switch to the input signal source you select.

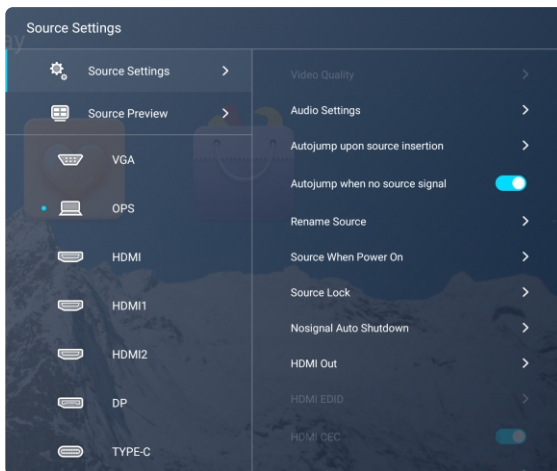

Remark: the picture is for reference only, subject to the actual signal source menu.

## Source Settings

Select the sidebar menu, click the “” icon, and select to the right to enter the “Source Settings” submenu to set the video quality, audio settings, autojump upon source insertion, autojump when no source signal, rename source, source when power On, source Lock, nosignal auto shutdown, HDMI out, HDMI EDID, HDMI CEC, auto adjust, source UI translucent.

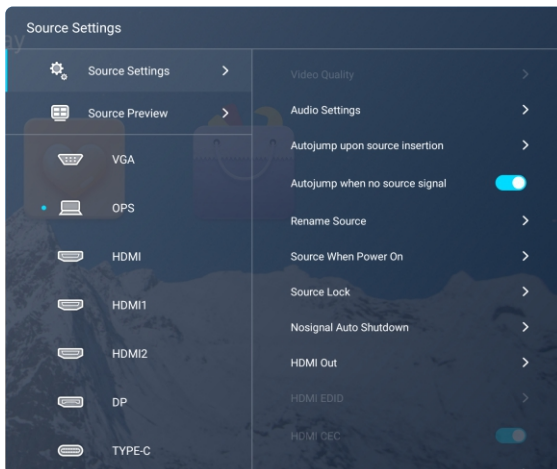

# Basic Operations

## Source Preview

Select the sidebar menu, click the “” icon, and select to the right to enter the “Source Preview” submenu, you can preview HDMI, HDMI1, HDMI2, OPS, VGA, TYPE-C and DP sources.

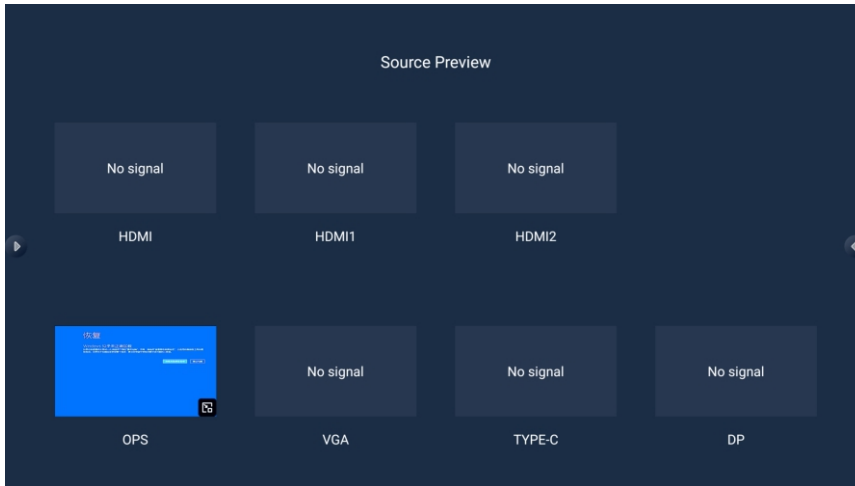

## Sound Mode

Select the sidebar menu, click the “” icon, and select to the right to enter the “Source Preview” sub-menu. At this time, click the “Audio Settings” sub-option to adjust the volume, channel balance, bass and treble.

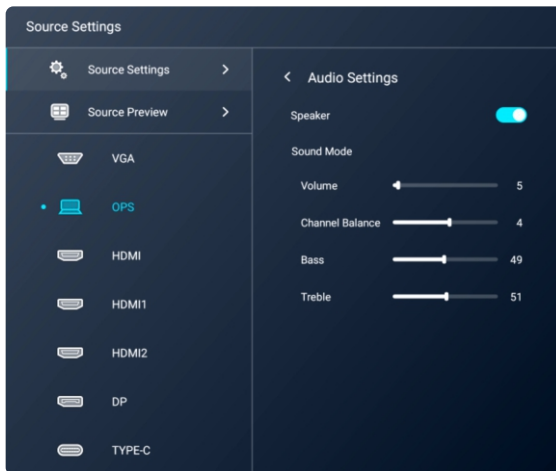

## Network and Connection

Select sidebar menu, press the setting icon and then enter systems setting page where it can conduct wireless network, wired network, wireless hot spot setting.

### ◆ Wireless

1. Select sidebar menu > System Settings > Network and Connection > Wireless.
2. Turn on WLAN switch.

# Basic Operations

3. Select the network to be connected from Network List, enter the connecting password, and then success to connect the wireless network.
4. If there is no desired network in Network List, it can manually add a network.

## ◆Ethernet

1. Connect one end of the network cable to the network port of this machine before using wired network, and then connect the other end to a router.
2. Select sidebar menu > System Settings > Network and Connection > Ethernet.
3. Turn on connecting switch.
4. Select “Auto” in IP settings, and then the machine will automatically obtain an IP address and connect to network.
5. Select “Static” in IP settings, manually input IP address, gateway, network prefix length, DSN address, and then click “Finish” to connect to network.

★Remark: there are two network ports on this machine, either of which can be connected to wired network (choose one of them). When one network port is connected with a router, the other port can be connected with an external device. At this time, the Android system of this machine, OPS (Windows system only) and the external device form a LAN, which can be connected to network at the same time.

## ◆Hotspot

1. Select sidebar menu > System Settings > Network and Connection > Hotspot.
2. Turn on hotspot switch.
3. Enter the hot spot name in the textbox, and the system defaulted name is “AndroidAP-7763” which is changeable into other name.
4. Select “encrypt or not”.
5. After encryption is selected, the system will automatically configure a password or it can also enter a password in the password box.
6. Click “OK” to save setting, and then this network can be found by other WIFI devices within the range when they search WIFI networks.

★Note: please set the network password and complicate it as much as possible.

## ◆Bluetooth

1. Select sidebar menu > System Settings > Network and Connection > Bluetooth.
2. Turn on bluetooth switch.
3. Choose the bluetooth device pair to connect.

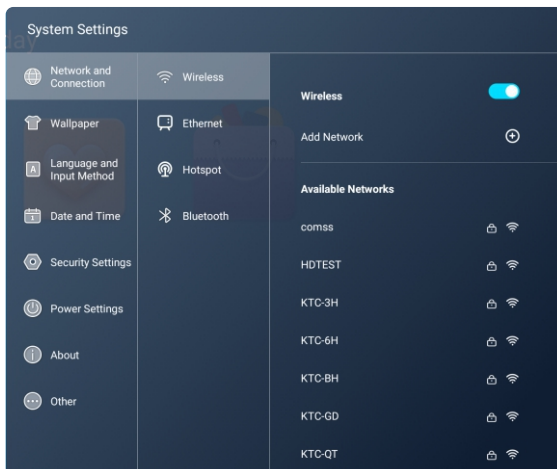

# Basic Operations

## Wallpaper

Select the sidebar menu, click the “📷” icon, and select to the right to enter the “Wallpaper” submenu, you can add wallpaper and set wallpaper shuffling.

◆Note: The format of wallpaper and Lock screen wallpaper should be PNG, and the resolution should be 1920\*1080 or 3840\*2160, but the file should not be too larger, so as not to import and affect the smooth operation of the system.

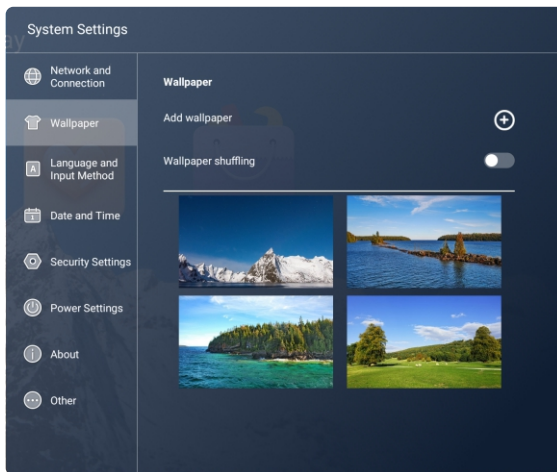

## Language and Input Method

Select the sidebar menu, click the “🗣️” icon, and select to the right to enter the “Language and Input Method” submenu, you can select language and input method.

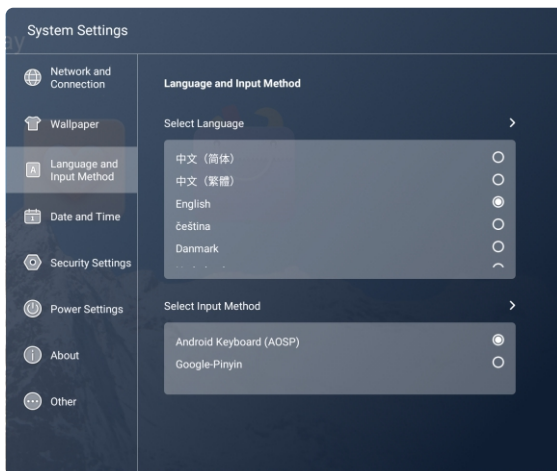



# Basic Operations

## Date and Time

Select the sidebar menu, click the “🔒” icon, and select to the right to enter the “Date and Time” submenu to set the automatically determine date and time, manually set date and time.

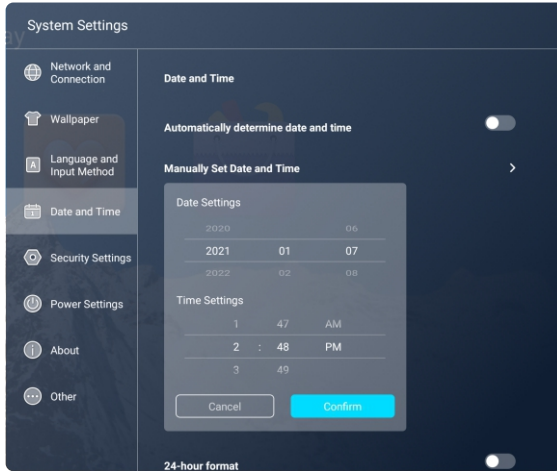

## Security Settings

Select the sidebar menu, click the “🔒” icon, and select to the right to enter the “Security Settings” submenu to set the close password, pattern password and digital password.

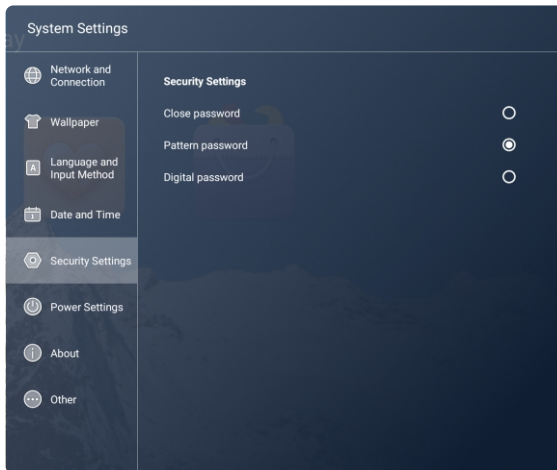

# Basic Operations

## Power Settings

Select the sidebar menu, click the “” icon, and select to the right to enter the “Power Settings” submenu to set the power-on mode, screen off and standby, timer for power on/off and auto wakeup.

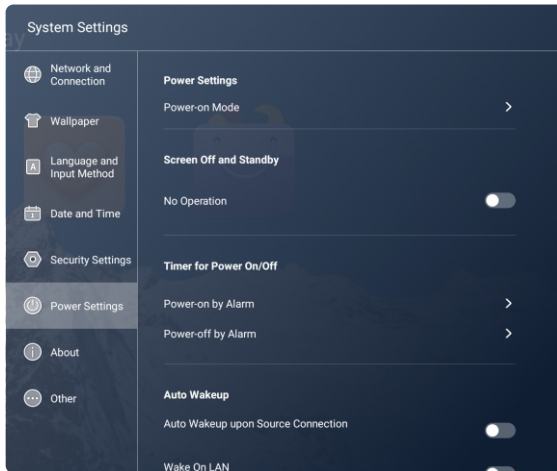

## About

Select the sidebar menu, click the “” icon, and select to the right to enter the “Security Settings” submenu to view the update, device name, device mode, serial number, running memory, available storage, resolution, android version, system version and touch frame version.

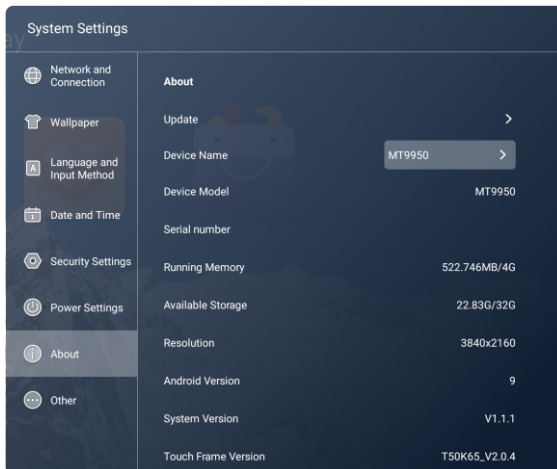

# Basic Operations

## Other

Select the sidebar menu, click the “🔒” icon, and select to the right to enter the “Other” submenu to set the small lock (remote lock, touch lock and button lock), float bar and sidebar gesture switch.

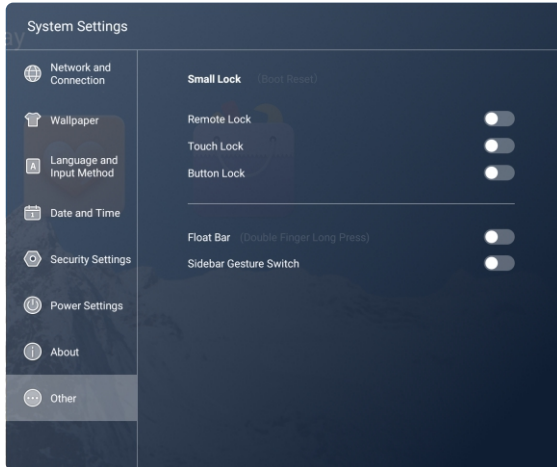

## Utilities

Select the sidebar menu, click the “🔒” icon to select screen lock, eye protection, calculator, vote, screencapture, screen recorder, stopwatch, spotlight, touch Sound and Countdown.

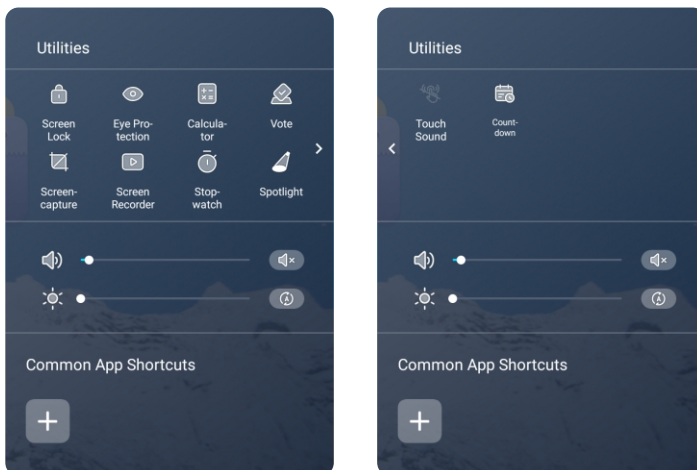

**Note:** The widgets system preset above are for reference only and are subject to change without prior notice.

# Basic Operations

## MultitaskManager

Select the sidebar menu, click “” icon to view and manage background running processes.

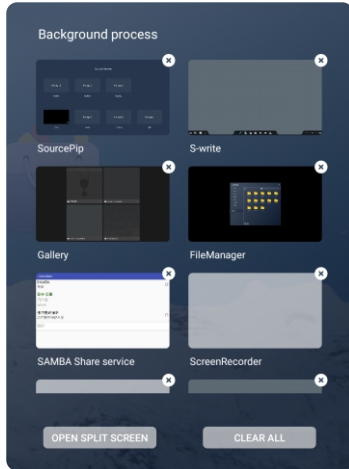

## Turnoff

Select the sidebar menu, click the “” icon to select turn off OPS and turnoff.

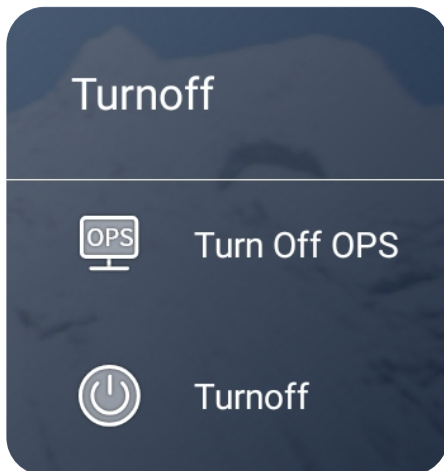

# Basic Operations

## FileManager

Select the sidebar menu, click the “” icon to enter the “FileManager”. The document manager supports the playing of images, videos, audio, etc. Long pressing can move, copy, delete selected document.

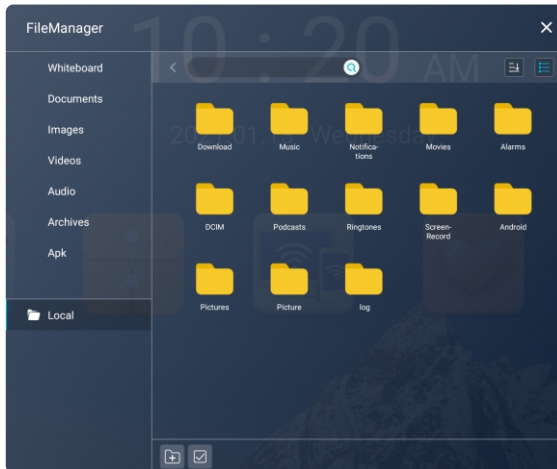

## Homepage

There are time, date, flash drive information, network information, hot spot information and shortcuts for whiteboard and file manager on the home page. All apps include system apps and third party apps.

(Note: The homepage background and icons are subject to practical products.)



### ★Special tips

User can install new application and the operations may vary. The operation methods detailed in this Manual are for reference only. User shall operate the machine according to the actual situation.









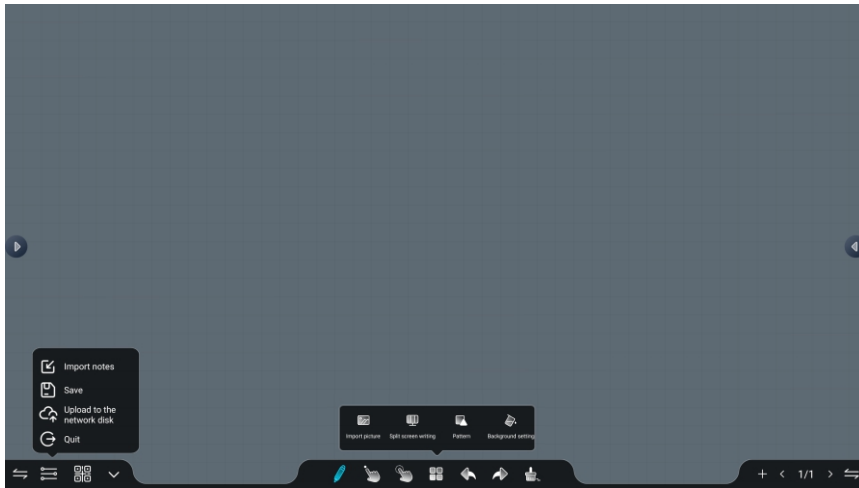

# Basic Operations











## Writing Software

The electronic whiteboard writing software contains selection, background setting, brush setting, undo, restore, text, clear screen, save, import picture, spot light and split screen and other functions.

(Note: The writing software function will be updated in real time are subject to practical products.)



	Import notes
	Save
	Upload to the network disk
	Quit
	Hide bottom sidebar
	Add pages
	Previous page
	Next page
	Side bar change left and right
	QR code scanning and sharing

	Brush setting
	Single point/multi-point
	Lasso Move
	Import picture
	Split screen writing
	Pattern
	Background setting
	Previous Step
	Next Step
	One Key Clear

# Technical Parameters

## Mode Display VGA

NO.	Mode	Resolution	Refresh Rate
1	VGA	640X480	60Hz
2	SVGA	800X600	60Hz
3	XGA	1024X768	60Hz
4	WXGA	1360X768	60Hz
5	WUXGA	1920X1080	60Hz

## Mode Display HDMI

NO.	Mode	Resolution	Refresh Rate
1	SD	720X480	70Hz
2		720X576	50Hz
3		1280X720	50Hz
4		1280X720	60Hz
5	HD	1920X1080	50Hz
6		1920X1080	60Hz
7	UD	3840X2160	30Hz
8		3840X2160	60Hz

# Troubleshooting

## Special Tips:

Please check the following table to see if it can help to find out the reason for the malfunction encountered before performing maintenance. When it still cannot remove the fault according to the operation of this instruction book completely, please contact the service center to conduct product maintenance.

Symptom	Possible Cause	Solution
The screen does not display anything; there is no sound, and the indicator does not come on	Looseness of power plug, power connection failure	Check if the power cord is properly connected
Pictures shown on the product have dotted line or stripe interference	Signal interference caused by automobile, neon light, electric hairdryer, etc.	Try to find out the machine that affect the product, and then put them away from the product, or insert the power plug to another socket.
Pictures shown on the PC are offset, do not cover the entire screen, go beyond the screen, or are blurred	1.Improper adjustment 2.Wrong display mode	1.Use the auto adjustment function 2.Enter "PC Screen Adjustment" to adjust the horizontal or vertical position 3.Use the recommended mode
Short remote control distance, malfunction of remote control	1.The remote receiver of the product is blocked by some other object 2.Battery level of the remote control is low	1.Move the object to avoid blocking the remote receiver 2.Replace the battery
The product gets stuck, crashes or cannot be operated	1.Too many programs are running 2.Normal operation of the product is disturbed by external environment (e.g., lightning, static electricity)	Disconnect the product from power supply; wait for 1-2min and reconnect power supply; then restart the product
The touch is slow, it doesn't work	Too many programs are running	Clean up a program that runs memory large or restart the product
OPS can't be turned on, no display, no touch	OPS has not been fixed well	Reinstall the OPS computer
Touch excursion	Caused by the computer's coordinate system, need to do some correction.	Enter the control panel to select the correction processing
Invalid touch of the external computer	1.the signal source is inconsistent with the corresponding interface of the touch USB cable 2.the touch USB cable is too long or of low quality	1.Check and change the corresponding interface of the touch USB cable, 2.Change another shorter or better quality touch USB cable.



## Important Statement on Network Service

All contents and services obtained from the machine are owned by third parties and protected by copyright, patent, trademark and/or other intellectual property laws. These contents and services are only for your personal non-commercial purposes, which shall not be used in a way not authorized by the content owner or service provider. Under no circumstance shall our Company be liable for any direct, indirect or unexpected losses or damages arising from your or any third party's access to any contents or services or any information or third-party software through this product.

Third-party services may be subject to change, removal or discontinuation without prior notice. Our Company does not represent or warrant that some services or contents will remain accessible at any time.

Our Company will not be responsible for any service related to these contents and services, or assume any liability for customer service. For any question or service request about these contents and services, please directly contact the corresponding content or service provider.

## Toxic/Hazardous Substances/Elements in the Product

Component	Toxic and Hazardous Substance or Element					
	(Pb)	(Hg)	(Cd)	(Cr <sup>6+</sup> )	(PBB)	(PBDE)
Display screen	×	○	○	○	○	○
Housing	○	○	○	○	○	○
PCBA*	×	○	○	○	○	○
Power cord and cables	×	○	○	○	○	○
Metal parts	○	○	○	○	○	○
Packing materials*	○	○	○	○	○	○
Remote control	×	○	○	○	○	○
Speaker	×	○	○	○	○	○
Accessories*	○	○	○	○	○	○

This table has been prepared in accordance with GB/T26572-2011.

\*: PCBA includes the PCB and its electronic components;

Packaging materials include the carton, EPS, etc.

Other accessories include the User's Manual, etc.

○ : The content of such toxic/hazardous substance in all homogeneous materials of such component are under the content limit specified in GB/T26572-2011.

× : The content of such toxic/hazardous substance in one or more homogeneous materials of such component goes beyond the content limit specified in GB/T26572-2011.

As shown in the above table prepared based on the data provided by our material suppliers for each type of materials and verified by us, this product contains hazardous substances. The hazardous substances contained in some materials are irreplaceable at the current technological level although we've been trying to make improvements.

The environment-friendly use period of this product is 10 years (see the pollution control symbol in the right figure).



Such use period will be maintained under the normal working conditions specified in the User's Manual only.

### Indicative Description of Regulations on Recycling and Disposal of Waste Electrical and Electronic Products.

To care for and protect the earth better, please send it to a local manufacturer with nationally recognized qualification for recycling according to the national applicable laws and regulations on recycling of waste electrical and electronic products when you no longer need this product or at the end of its service life.



The terms HDMI and HDMI High-Definition Multimedia Interface, and the HDMI Logo are trademarks or registered trademarks of HDMI Licensing Administrator, Inc. in the United States and other countries.



This Manual is provided for reference only. The functions of the actual product are subject to change without further notice.